

MAGIS

Steelwood by Ronan & Erwan Bouroullec



Ronan & Erwan Bouroullec



Profile:

Ronan Bouroullec (born in 1971) and Erwan Bouroullec (born in 1976) have been working together for more than twenty years now. Their collaboration is a permanent dialogue, nourished by their distinct personalities and a shared notion of diligence, with the intention to achieve greater balance and refinement.

In 1997, they presented their Disintegrated Kitchen at the Salon du Meuble in Paris, where it was spotted by Giulio Cappellini, who gave them their first industrial design commissions. The Bouroullecs have been working with Magis since 2004, designing three complete furniture collections – Striped, Steelwood and Officina – as well as additional projects such as Pila chair, Pilo table, Central and Tambour tables. These days, Ronan and Erwan Bouroullec design for numerous manufacturers, including Magis, Vitra, Kvadrat, Kartell, Established and Sons, Ligne Roset, Axor, Alessi, Issey Miyake, Cappellini, Mattiazzi, Flos, Mutina,

Hay and more recently Glas Italia and Iittala. They also continue to carry out their own experimental activity which is essential to the development of their work at Galerie kreò, Paris, where four exhibitions of their designs were held between 2001 and 2012. They also embark on occasional architectural projects.

Voted Designers of the Year at the Salon du Meuble in 2002, their other awards include the Compasso d'Oro won in 2011 for the Steelwood chair they designed for Magis.

Several exhibitions have been devoted to their work.

In 2012, Phaidon Press published *Works*, a comprehensive monographic book about Ronan and Erwan Bouroullec. Previously, two other monographs had been published about the Bouroullec brothers' design work: *Ronan et Erwan Bouroullec – Catalogue de Raison* (Paris: Images Modernes / kreò, 2002) and *Ronan et Erwan Bouroullec* (Paris: Phaidon Press, 2003).



Design and

Designed by Ronan & Erwan Bouroullec, the Steelwood collection is the combination between two traditional materials, wood and steel plate, which together create simple yet elegant and sophisticated design products. The first product produced was the Steelwood Chair, but today the family includes also stools, tables, a modular book-case and a coat hanger.

The combination of the two materials is not new, but still innovative. The structural framework of all Steelwood products is formed by steel plate painted in polyester powder, while the supporting function is given by wooden elements. The respective role of the components is visible and results in a coherent overall picture.

The Bouroullecs consider their Steelwood Chair “stable and democratic, universal and long-lasting.” Its silhouette makes it an easy chair, adaptable to any place from contract spaces to cosy homes. The use of solid materials and modern technologies associated with an artisan component lead to a quality and sustainable product. Thanks to these features, this chair obtained the prestigious Compasso d’Oro Award in 2011.

The particularity and complexity of this chair is given by the backrest that is a veritable technical gem: its curved form is achieved through a process involving nine different phases: the steel plate is perforated and bent, alternating industrial technology with artisanal attention to detail. The final step is the painting in polyester powder. We can say that high-tech industrial processes alternate with artisanal ones.

The Steelwood collection combines traditional shapes, solid materials and modern technology in a contemporary product of exceptional quality.

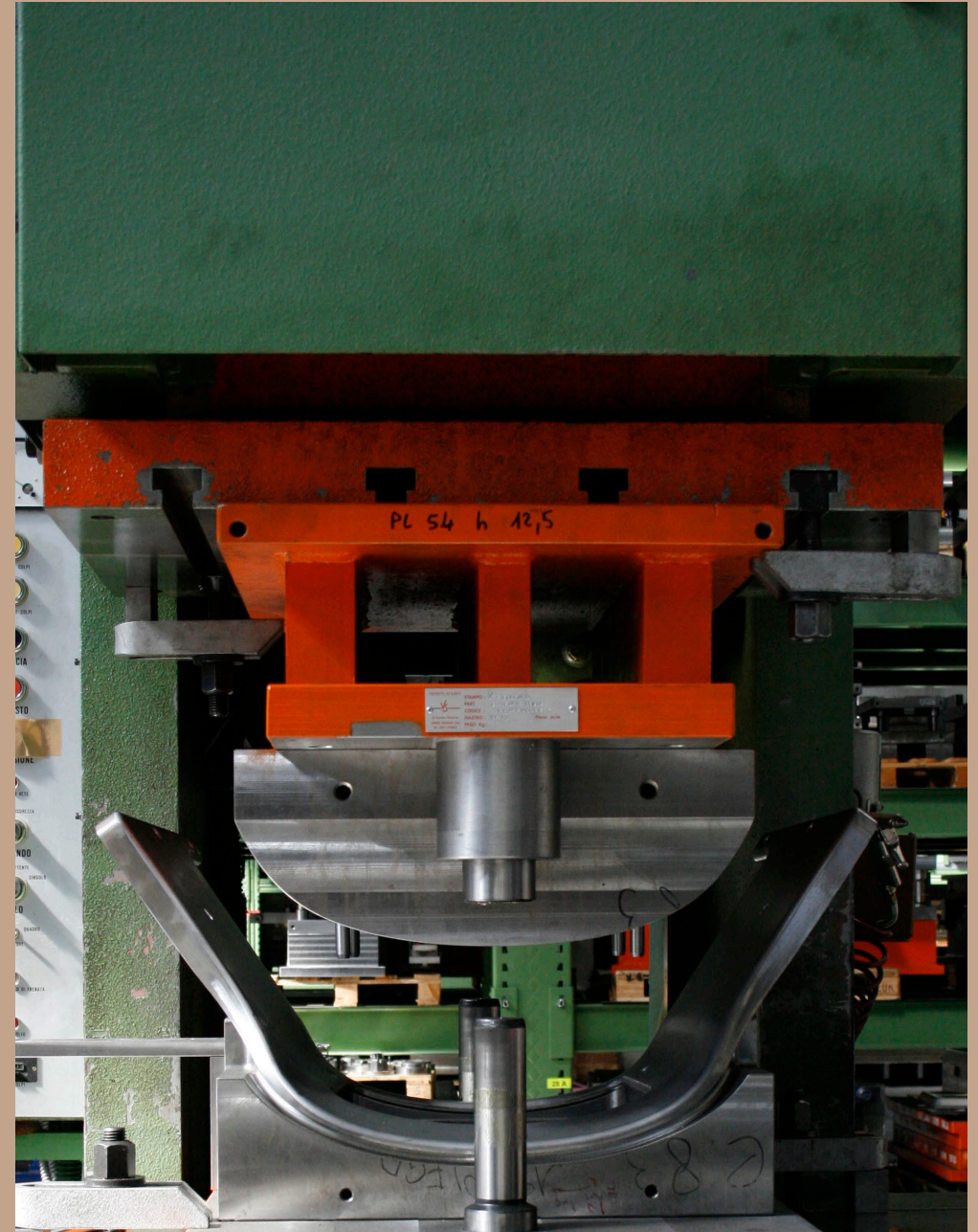

Engineering



“The Steelwood chair is stable and democratic,



universal and long-lasting.”

Ronan & Erwan Bouroullec

Information



Product

STEELWOOD CHAIR

Chair with arms. Legs and seat in solid beech, natural or painted or stained, or in solid American walnut natural, or in solid oak, natural or stained. Frame in steel plate painted in polyester powder. Complete with felt pads.

Chair with arms and seat upholstered. Legs in solid beech, painted. Frame in steel plate painted in polyester powder. Seat in plywood padded in expanded polyurethane foam, fireproof (CLASS 1IM) covered in fabric (Kvadrat, "Divina 3 and Divina MD"). Complete with felt pads.



Compasso d'oro 2011

STEELWOOD STOOL

Legs in solid beech, natural or painted or stained, or in solid American walnut natural or in solid oak, natural or stained. Seat and foot-rest in steel plate painted in polyester powder. Complete with felt pads. Seat cushion available.

STEELWOOD TABLE

Frame (legs and crosspieces) in solid beech, natural or painted. Joints in steel plate painted in polyester powder. Top in HPL.

STEELWOOD SHELVING SYSTEM

Frame (uprights and crosspieces) in solid beech, natural or painted. Joints in steel plate painted in polyester powder. Shelves in painted MDF.

STEELWOOD COAT STAND

Frame in solid beech, natural or painted or in solid American walnut. Joints in steel plate painted in polyester powder.

STEELWOOD CHAIR



seat / beech natural 7011
frame / white 5108



seat / beech natural 7011
frame / black 5140



seat / oak natural 7310
frame / white 5108



seat / oak natural 7310
frame / grey 5119



seat / oak natural 7310
frame / black 5140



seat / American walnut
frame / black 5140



seat / beech stained dark
frame / black 5140



seat / oak stained dark
frame / grey anthracite 5142



seat / beech white 7180
frame / white 5108



seat / beech grey
frame / grey 5119



seat / beech grey anthracite
frame / grey anthracite 5142



seat / beech black
frame / black 5140

Materials /

Frame in steel plate painted /

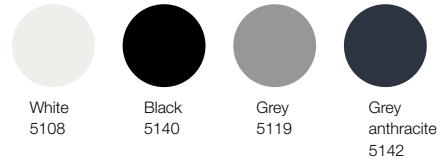

Seat and legs in solid wood natural or painted or stained /

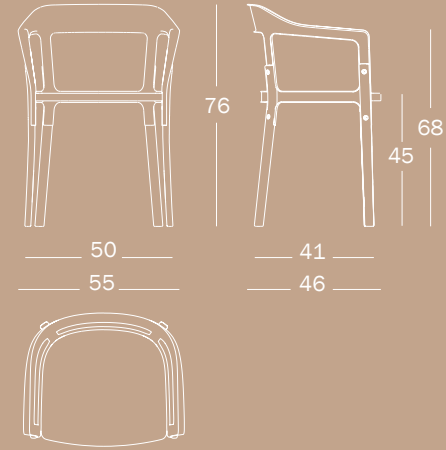

PRODUCT CARE

We recommend using a soft, either dry or wet, rag. When needed, use ph-balanced soap diluted in water and ph-balanced liquid soap especially formulated for wood, diluted in water. Do not use abrasive sponges as they may leave scratches. Avoid using acidic products, solvents and products containing ammonia. Avoid exposure to sunlight. Periodic and correct maintenance allow the product to keep its original aspect and lengthen the duration of its performance.

WARNING

Do not use different cleaning products from the ones mentioned above. Do not use the product in an improper way. Do not place hot objects on it, sit on the back and/or on the arms, stand on it or use the product as a ladder. Once disused, please make sure this product is disposed in an environment-friendly way.

STEELWOOD CHAIR w/ seat upholstered



frame and legs / white or black
seat / kvadrat white



frame and legs / white or black
seat / kvadrat orange



frame and legs / white or black
seat / kvadrat green



frame and legs / white or black
seat / kvadrat dark brown



frame and legs / white or black
seat / kvadrat black



frame and legs / white or black
seat / kvadrat dark grey



frame and legs / white or black
seat / kvadrat grey



frame and legs / white or black
seat / kvadrat pink



frame and legs / white or black
seat / kvadrat dark blue

Materials /

Frame in steel plate painted /



White 5108
Black 5140

Legs in solid beech painted /



Beech white 7108
Beech black 7140

fabric /

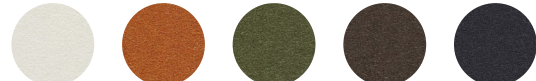

Kvadrat Divina 3 106 / white
Kvadrat Divina 3 552 / orange
Kvadrat Divina 3 984 / green
Kvadrat Divina 3 393 / dark brown
Kvadrat Divina 3 191 / black



Kvadrat Divina MD 193 / dark grey
Kvadrat Divina MD 713 / grey
Kvadrat Divina MD 613 / pink
Kvadrat Divina MD 783 / dark blue

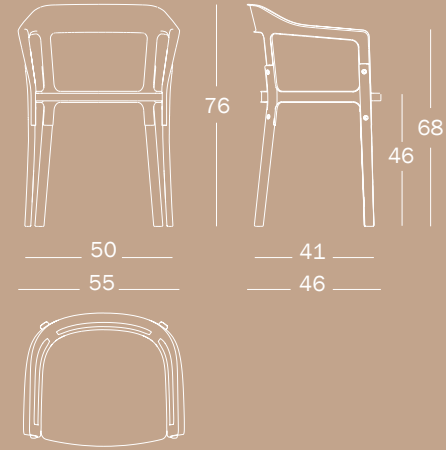

PRODUCT CARE

We recommend using a soft, either dry or wet, rag. When needed, use ph-balanced soap diluted in water and ph-balanced liquid soap especially formulated for wood, diluted in water. Do not use abrasive sponges as they may leave scratches. Avoid using acidic products, solvents and products containing ammonia. Avoid exposure to sunlight. Periodic and correct maintenance allow the product to keep its original aspect and lengthen the duration of its performance.

WARNING

Do not use different cleaning products from the ones mentioned above. Do not use the product in an improper way. Do not place hot objects on it, sit on the back and/or on the arms, stand on it or use the product as a ladder. Once disused, please make sure this product is disposed in an environment-friendly way.



STEELWOOD STOOL



legs / beech natural 7011
seat / white 5108

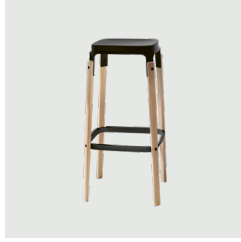

legs/ beech natural 7011
seat / black 5140

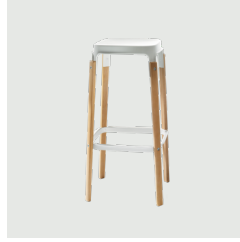

legs / oak natural 7310
seat / white 5108



legs / oak natural 7310
seat / grey 5119

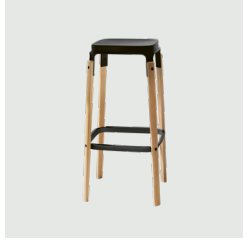

legs / oak natural 7310
seat / black 5140

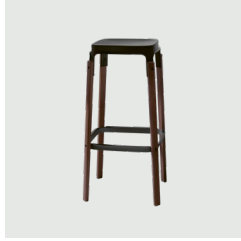

legs / American walnut
seat / black 5140



legs / beech stained dark
seat / black 5140



legs / oak stained dark
seat / grey anthracite 5142



legs / beech white 7180
seat / white 5108



legs / beech grey
seat / grey 5119



legs / beech grey anthracite
seat / grey anthracite 5142

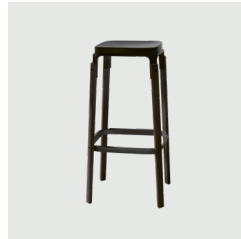

legs / beech black
seat / black 5140

Materials /

Seat and foot-rest in steel plate painted /

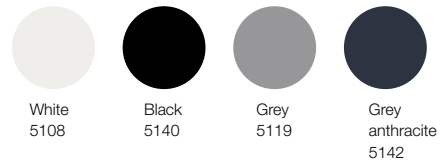

Legs in solid wood natural or painted or stained /

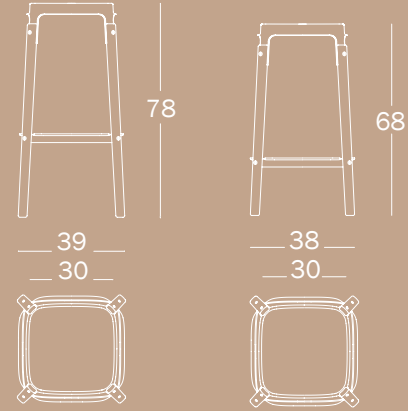

STEELWOOD STOOL CUSHION



fabric /

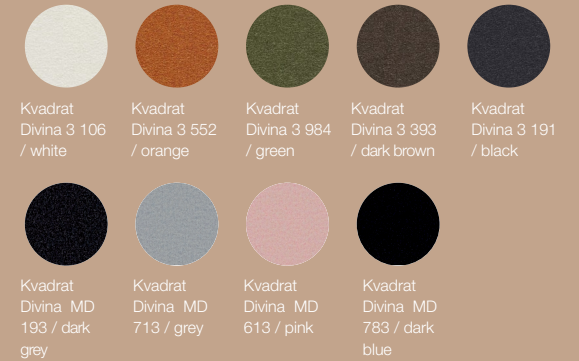

PRODUCT CARE

We recommend using a soft, either dry or wet, rag. When needed, use ph-balanced soap diluted in water and ph-balanced liquid soap especially formulated for wood, diluted in water. Do not use abrasive sponges as they may leave scratches. Avoid using acidic products, solvents and products containing ammonia. Avoid exposure to sunlight. Periodic and correct maintenance allow the product to keep its original aspect and lengthen the duration of its performance.

WARNING

Do not use the product in an improper way: do not use different cleaning products from the ones mentioned above; do not place hot containers on it, stand on the seat or use the stool as a ladder. Once disused, please make sure this product is disposed in an environment-friendly way.



STEELWOOD TABLE

Table 180x90 / 145x145 / 90x90 / Ø120

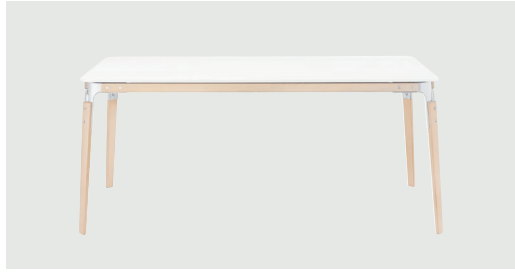

frame /
Natural 7011

top /
White 8500

joints /
White 5108

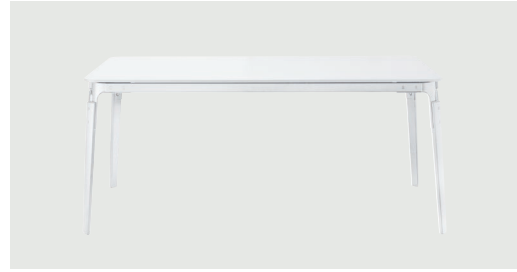

frame /
White 7108

top /
White 8500

joints /
White 5108



frame /
Black 7140

top /
Black 8510

joints /
Black 5140

Materials /

Frame in solid beech /

Top in HPL /

Joints in steel plate /



Beech
natural
7011

Beech
white
7108

Beech
black
7140



White
8500

Black
8510



White
5108

Black
5140

180x90

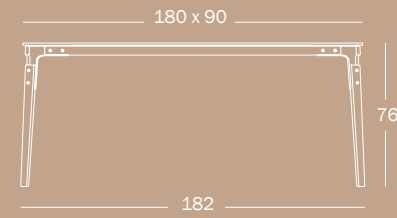

145x145

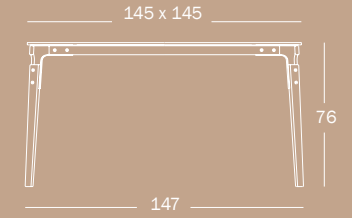

90x90

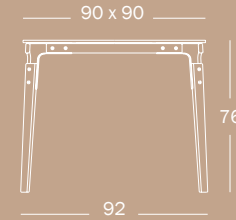

Ø120

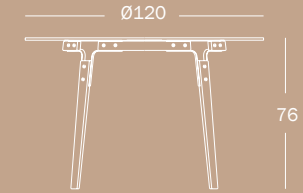
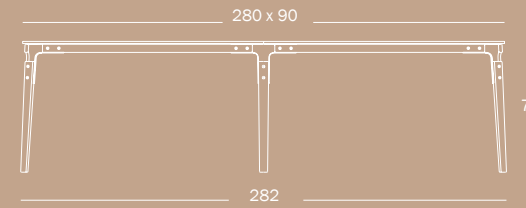
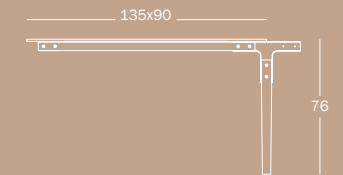

table system, basic module 280x90



intermediate module 135x90



examples of composition

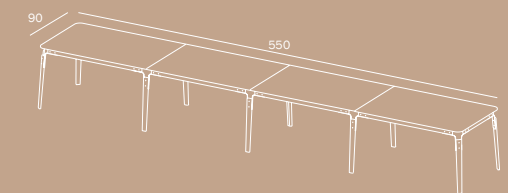
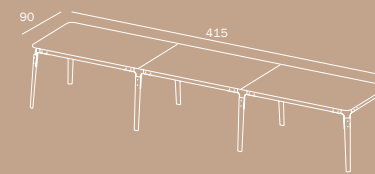

PRODUCT CARE

We recommend using a soft rag, either dry or wet. When needed, use ph-balanced soap diluted in water and ph-balanced liquid soap especially formulated for wood, diluted in water. Do not use abrasive sponges as they may leave scratches. Avoid using acidic products, solvents and products containing ammonia. Avoid exposure to sunlight. Periodic and correct maintenance allows the product to keep its original aspect and lengthens the duration of its performance.

WARNING

Do not use different cleaning products from the ones mentioned above. Do not use the product in an improper way. Do not place hot objects on it, stand on it or use the product as a ladder. Once disused, please make sure that this product is disposed in an environment-friendly way.



STEELWOOD SHELVING SYSTEM

module h 54cm



frame /	shelves in MDF /	joints /
White 7108	White 8500	White 5108
Black 7140	Black 8510	Black 5140
Natural 7011	White 8500	White 5108

examples of composition



Materials /

Frame in solid beech /

Shelves in MDF /

Joints in steel plate /



Beech
natural
7011



Beech
white
7108



Beech
black
7140



White
8500



Black
8510



White
5108



Black
5140

modular shelving system

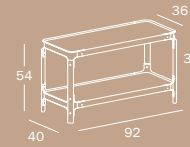

examples of composition

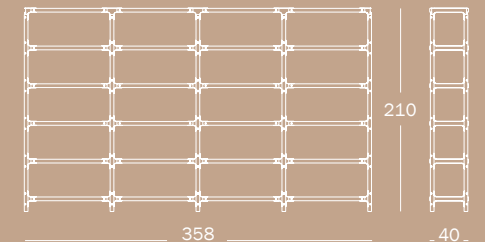
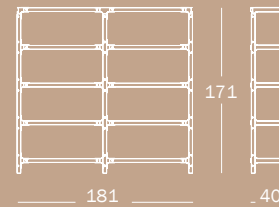
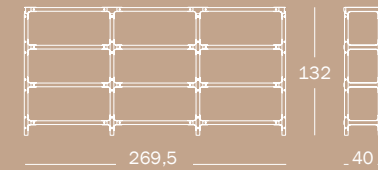
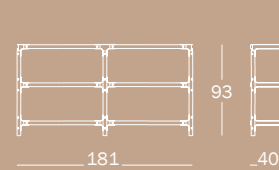
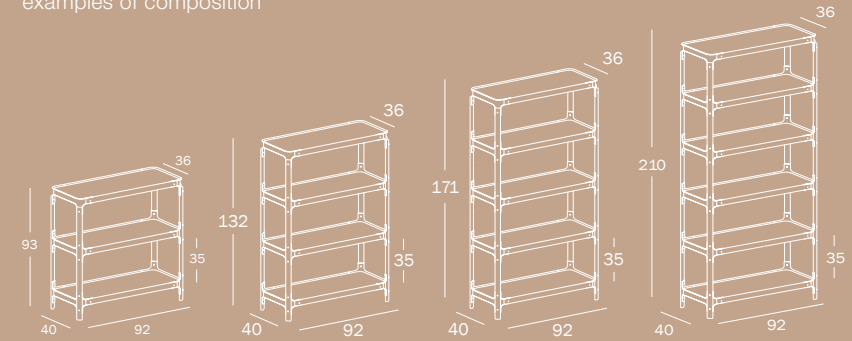

PRODUCT CARE

Clean the product using a soft, not abrasive rag, either dry or wet. When needed, use ph-balanced soap diluted in water and ph-balanced liquid soap especially formulated for wood, diluted in water. Do not use abrasive sponges as they may leave scratches. Avoid using acidic products, solvents and products containing ammonia. Avoid exposure to sunlight. Periodic and correct maintenance allows the products to keep their original aspect and lengthens the duration of their performance.

WARNING

Do not use the product in an improper way: do not use different cleaning products from the ones mentioned above; do not place hot containers on it, stand on the product or use it as a ladder. Once disused, please make sure this product is disposed in an environment-friendly way.



STEELWOOD COAT STAND

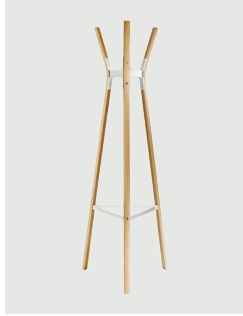

frame / beech natural
joints / white 5108

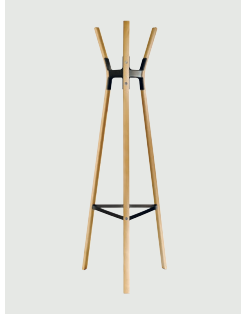

frame / beech natural
joints / black 5140



frame / beech white
joints / white 5108

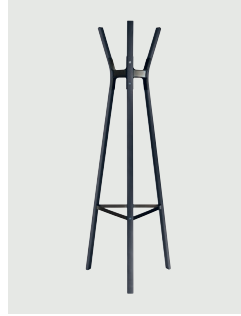

frame / beech black
joints / black 5140

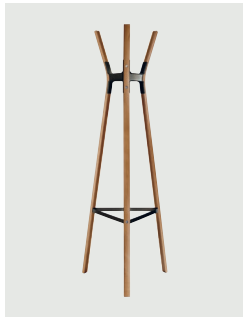

frame / American walnut
joints / white 5108

Materials /

Frame in solid beech /

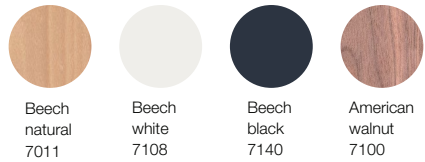

Beech
natural
7011

Beech
white
7108

Beech
black
7140

American
walnut
7100

Joints in steel plate /

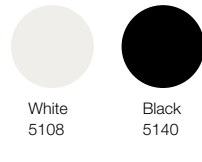

White
5108

Black
5140

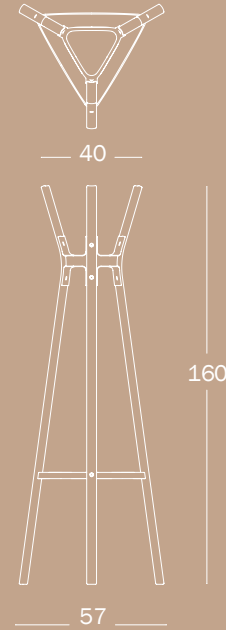

PRODUCT CARE

Clean the product using a soft, not abrasive rag, either dry or wet. When needed, use ph-balanced soap dilute in water and ph-balanced liquid soap especially formulated for wood, diluted in water. Do not use abrasive sponges as they may leave scratches. Avoid using acidic products, solvents and products containing ammonia.

Avoid exposure to sunlight. Periodic and correct maintenance allows the products to keep their original aspect and lengthens the duration of their performance.

WARNING

Do not use the product in an improper way: do not use different cleaning products from the ones mentioned above; do not climb on it or use it as a ladder. Once disused, please make sure this product is disposed in an environment-friendly way.

